

# COMBUS

Technical information



## Other documents available for this product

Ordering guidelines for COMBUS cabinets & shelving

## 10 year Warranty

See Warranty statement



---

# Technical information

## Types

- Shelving unit – modular configurations (1)
- Planter shelf unit – ready-made configurations (2)
- Shelving unit for mounting on cabinets – ready-made configurations (3)

1



2



3



## Shelving unit

### Frame

- 25x25 mm welded metal tube;
- Bottom part is made of bended metal sheet, 350x25x150 mm;
- Powder coated metal;
- Plastic feet with height levelling (+10 mm);
- Metal frame construction is easy to assemble and disassemble;

### Plinths

- 362x80x25 mm and 750x80x25 mm, bended metal sheet;
- Powder coated metal.

### Connecting component

- For shelf combination connection;
- 95x95 mm metal plates, made of 1,5 mm steel.

### Fixing components

- Fittings for fixing to the floor (included in the package);
- Set of fittings for mounting to the wall (order separately);
- Counterweight (order separately), made of 25 mm MFC (melamine) with 0,5 mm ABS edging;
- For more details about fixing types and the right selection of them, please read additional information.

### Shelves (1)

- 25 mm MFC (melamine) with 2 mm ABS edging;
- 25 mm chipboard covered in veneer with 1,5 mm edging;
- Load capacity for 362 mm width– 20 kg;
- Load capacity for 750 mm width– 25 kg.

### Shelf box (2)

- 25 mm MFC (melamine) with 2 mm ABS edging;
- 25 mm chipboard covered in veneer with 1,5 mm edging;
- Available with open or closed back;
- Load capacity for 362 mm width– 20 kg;
- Load capacity for 750 mm width– 25 kg.

### Planter box (3)

- 25 mm MFC (melamine) with 2 mm ABS edging;
- 25 mm chipboard covered in veneer with 1,5 mm edging;
- Load capacity for 362 mm width– 20 kg;
- Load capacity for 750 mm width– 25 kg.

### Cabinet with drawer (4)

- Top and bottom are made of 25 mm MFC (melamine) with 2 mm ABS edging or 25 mm chipboard covered in veneer with 1,5 mm edging;
- Front, sides and back panel are made of 18 mm MFC (melamine) with 1 mm ABS edging or 18 mm chipboard covered in veneer with 1,5 mm edging;
- Drawer box made of 12 mm MFC (melamine) with 1 mm ABS edging;
- Soft closing function, full extension with hidden slides;
- Opening with a handle;
- Handle made of metal sheet, powder coated;
- Load capacity – 20 kg.

1

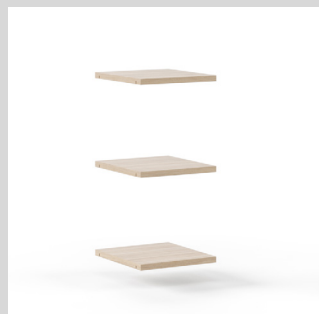

2



3



4



## Planter shelf unit

### Ready-made configurations

- Set of metal frame, planter box (1)
- Set of metal frame, 2 shelves, planter box (2)
- Set of metal frame, planter box, cabinet with drawer (3)
- Set of metal frame, 3 shelves, planter box (4)
- Set of metal frame, shelf, planter box, cabinet with drawer (5)

### Frame

- 25x25 mm welded metal tube;
- Top frame metal connector is made of welded metal tube, 750x25x25 mm;
- Bottom part is made of bended metal sheet, 350x25x150 mm;
- Powder coated metal;
- Plastic feet with height levelling (+10 mm);
- Metal frame construction is easy to assemble and disassemble.

### Plinths

- 362x80x25 mm and 750x80x25 mm, bended metal sheet;
- Powder coated metal.

### Connecting component

- For shelves combination connection;
- 95x95 mm - made of 1,5 mm steel.

### Fixing components

- Fittings for fixing to the floor (included in the package);
- Set of fittings for mounting to the wall (order separately);
- Counterweight (order separately), made of 25 mm MFC (melamine) with 0,5 mm ABS edging;
- For more details about fixing types and the right selection of them, please read additional information.

### Shelves

- 25 mm MFC (melamine) with 2 mm ABS edging;
- 25 mm chipboard covered in veneer with 1,5 mm edging;
- Load capacity for 362 mm width – 20 kg;
- Load capacity for 750 mm width – 25 kg.

### Planter box

- 25 mm MFC (melamine) with 2 mm ABS edging;
- 25 mm chipboard covered in veneer with 1,5 mm edging;
- Available in two sizes: 750x400x300 mm and 750x400x150 mm;
- Load capacity for 362 mm width – 20 kg;
- Load capacity for 750 mm width – 25 kg.

### Cabinet with drawer

- Top and bottom are made of 25 mm MFC (melamine) with 2 mm ABS edging or 25 mm chipboard covered in veneer with 1,5 mm edging;
- Front, sides and back panel are made of 18 mm MFC (melamine) with 1 mm ABS edging or 18 mm chipboard covered in veneer with 1,5 mm edging;
- Drawer box made of 12 mm MFC (melamine) with 1 mm ABS edging;
- Soft closing function, partial extension with hidden slides;
- Opening with a handle;
- Handle made of metal sheet, powder coated.
- Load capacity – 20 kg.

1

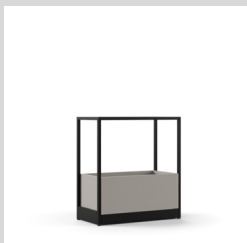

2



3



4



5



## Shelving unit for mounting on cabinets

### Ready-made configurations

- Four different 2H combinations (1)
- Six different 3H combinations (2)
- Six different 4H combinations (3)

### Frame

- 25x25 mm welded metal tube;
- Bottom part is made of welded metal sheet, 350x25x105 mm;
- Powder coated;
- Metal frame construction is easy to assemble and disassemble.

### Shelves

- 25 mm MFC (melamine) with 2 mm ABS edging;
- Load capacity for 362 mm width – 20 kg;
- Load capacity for 750 mm width – 25 kg.

### Shelf box

- 25 mm MFC (melamine) with 2 mm ABS edging;
- Available with open or closed back;
- Load capacity for 362 mm width – 20 kg;
- Load capacity for 750 mm width – 25 kg.

### Planter box

- 25 mm MFC (melamine) with 2 mm ABS edging;
- Load capacity for 362 mm width – 20 kg;
- Load capacity for 750 mm width – 25 kg.

### Fixing components

- Fittings for fixing on the cabinet (included in the package);
- Set of fittings for mounting to the wall (order separately);
- For more details about fixing types and the right selection of them, please read additional information.

1



2



3



## Accessories (optional)

### Back panel (1)

- 25 mm MFC (melamine) with 2 mm ABS edging;
- 25 mm chipboard covered in veneer with 1,5mm edging;
- Tool-free installation.

### PET felt back panel (2)

- 4 mm plywood covered with 9 mm PET fibreboard from both sides;
- Tool-free installation.

### Perforated metal sheet back panel (3)

- 1 mm metal sheet with perforated Ø8 mm holes;
- The edges are welded with metal profile;
- Powder coated metal;
- Tool-free installation.

### Metal planter box (4)

- 1 mm welded metal sheet;
- Powder coated metal;
- Two sizes: 360x407x160 mm and 748x407x160 mm;
- Placed on the shelves.

### Screen holder (5)

- Screen holder base is made from 1,5 mm powder coated metal sheet;
- VESA plate is made of 2 mm powder coated metal sheet;

- VESA standard – 75x75 mm, 100x100 mm, 200x200 mm, 300x300 mm;
- Recommended screen weight is up to 15 kg;
- Recommended screen size is up to 55";
- Screws for screen fixing to VESA plate are not included.

### Cable tray (6)

- 1 mm bended metal sheet - 1245x51x12 mm;
- Powder coated metal;
- Attached with two screws to the shelves above and with a metal pins under the plinth below.

### Book-end (7)

- 1 mm bended metal sheet – 250x160x230 mm;
- Powder coated metal;
- For placing on the shelves.

### Basket (8)

- 9 mm PET fibreboard;
- Binding screws, black painted or nickel-plated – 15 mm;
- Load capacity – 3 kg.

1



2



3

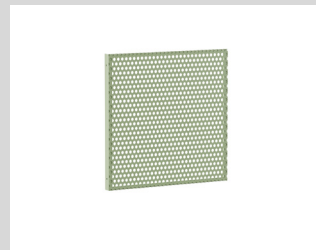

4



5



6

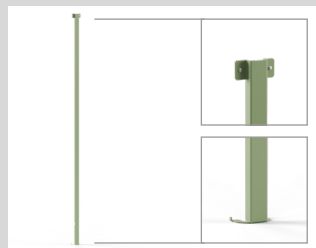

7



8



# Range

## Shelving units – modular configurations

### 3H start and end modules

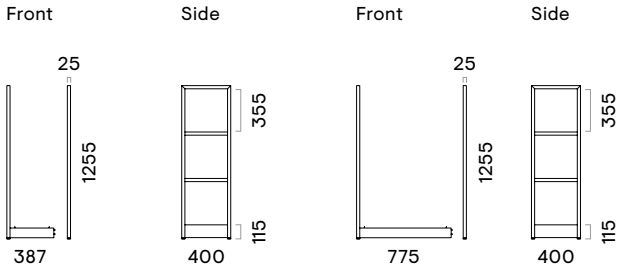

### 3H extension modules

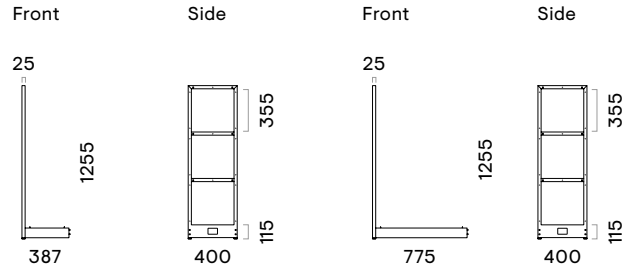

### 4H start and end modules

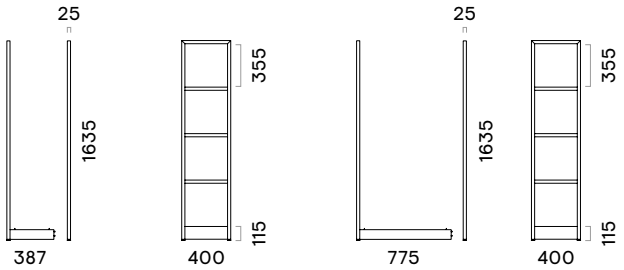

### 4H extension modules

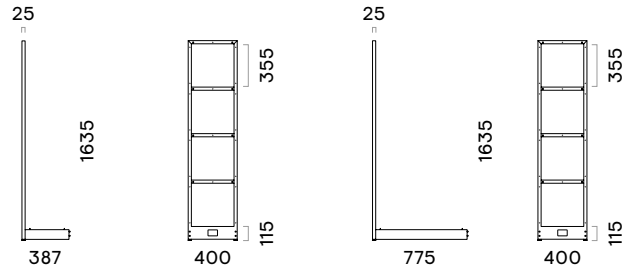

### 5H start and end modules

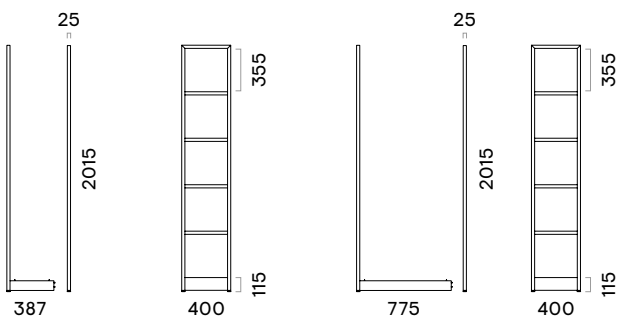

### 5H extension modules

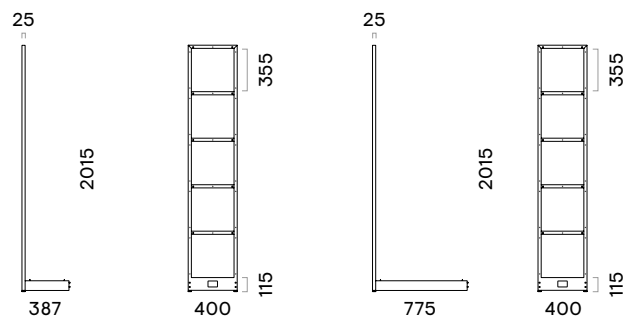

### 6H start and end modules

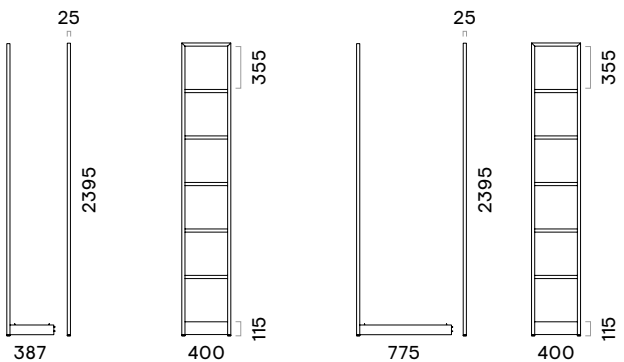

### 6H extension modules

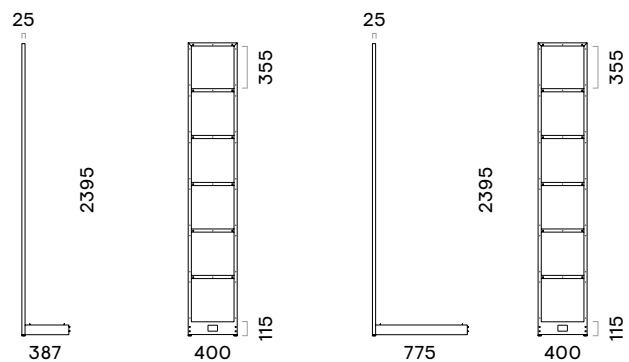



### Shelves

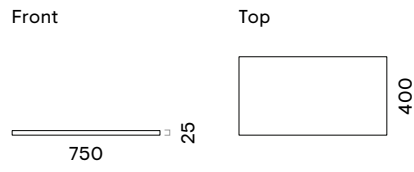
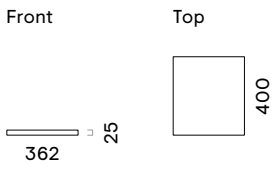

### Open and closed shelf boxes

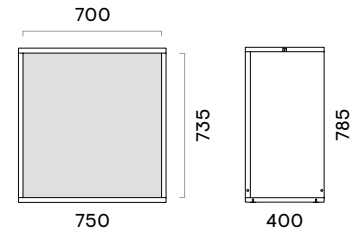
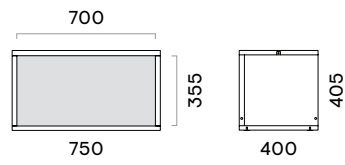
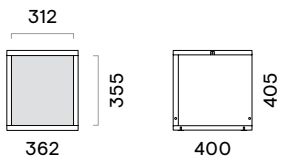
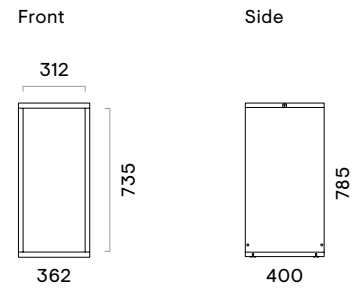
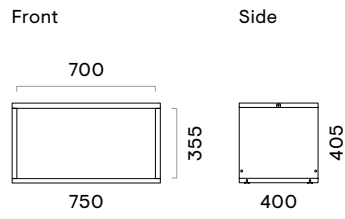
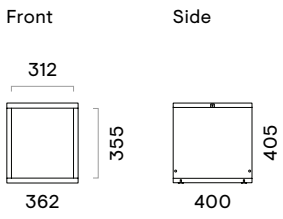

### Planter boxes

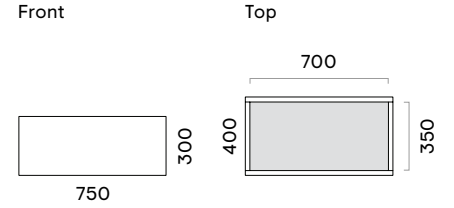
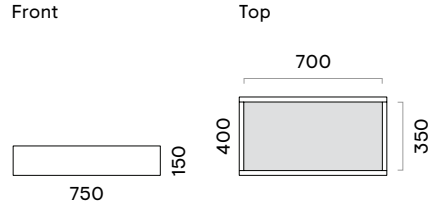
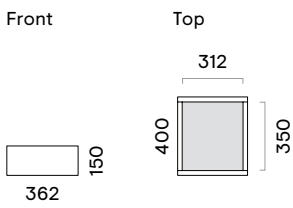

### Cabinet with drawer

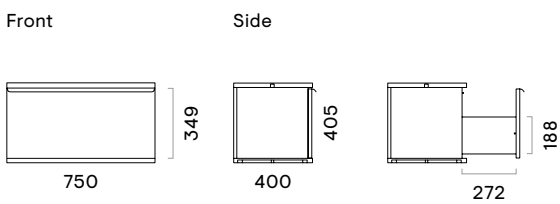

### Planter shelf units – ready-made configurations

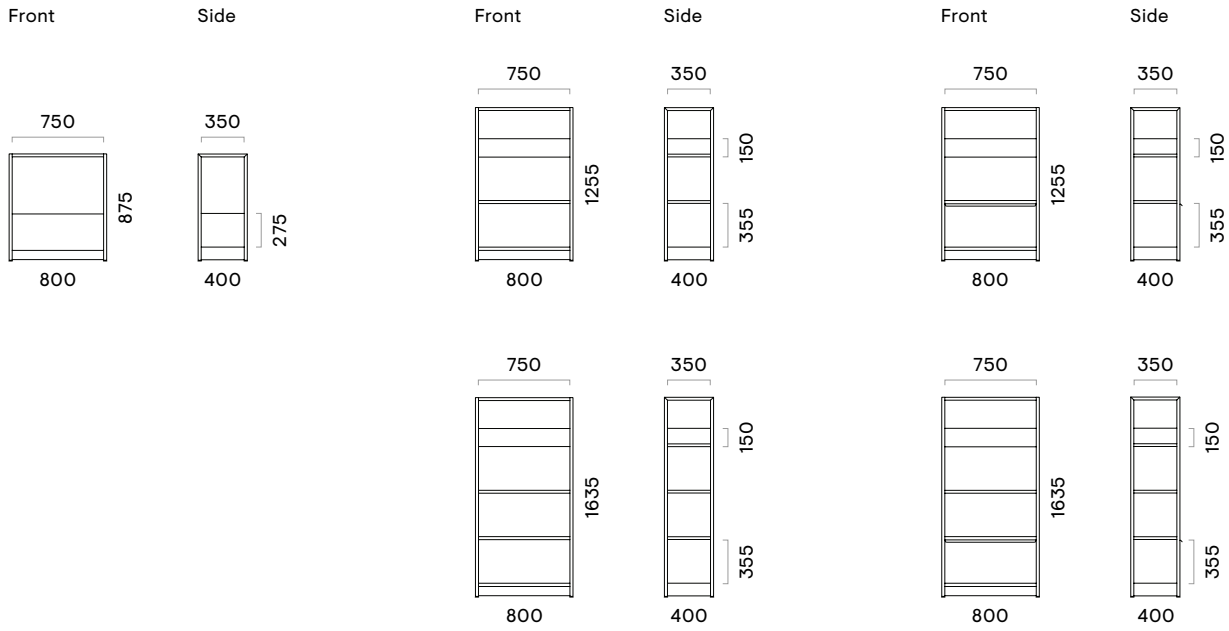

### Shelving units for mounting on cabinets – ready-made configurations

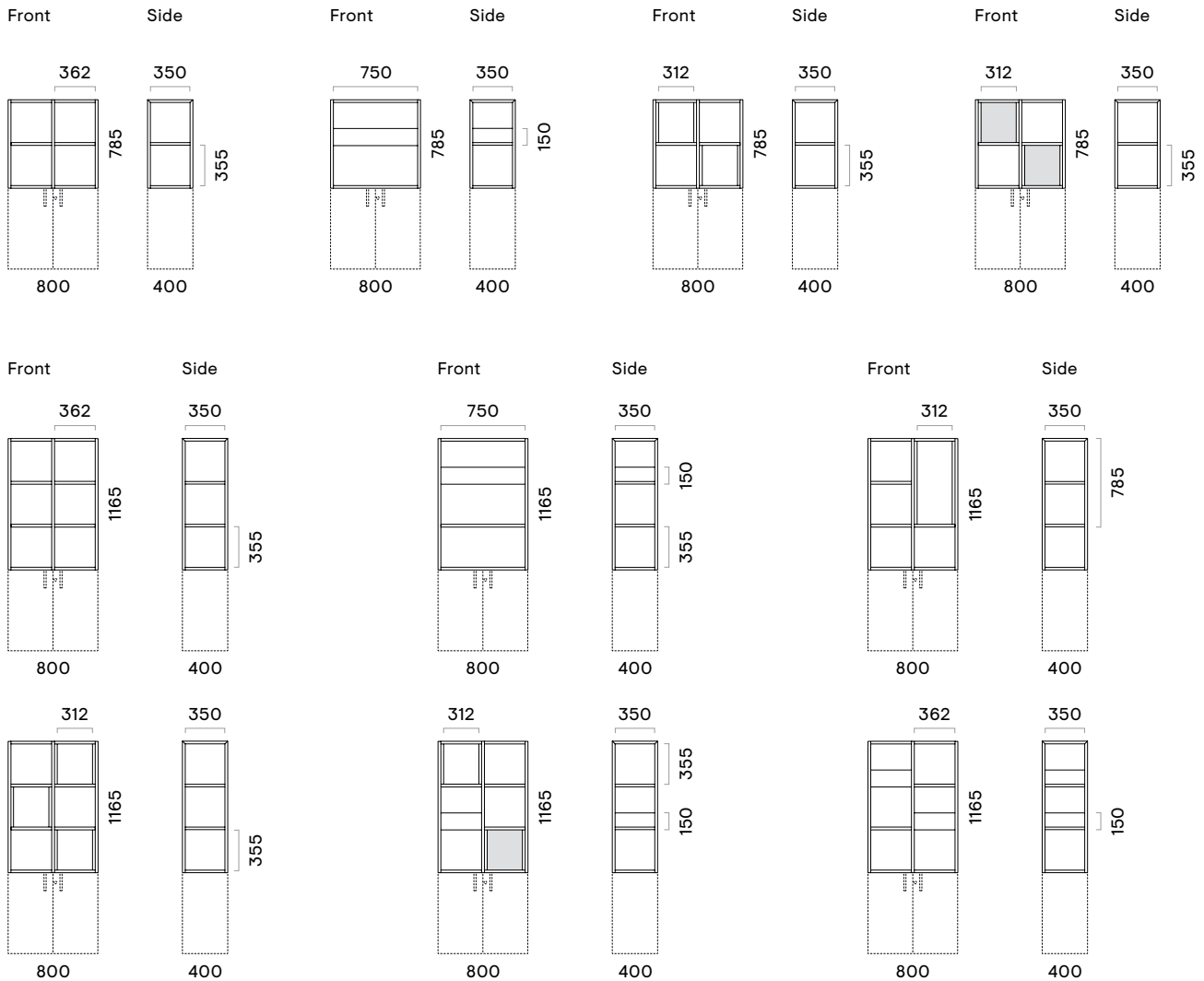

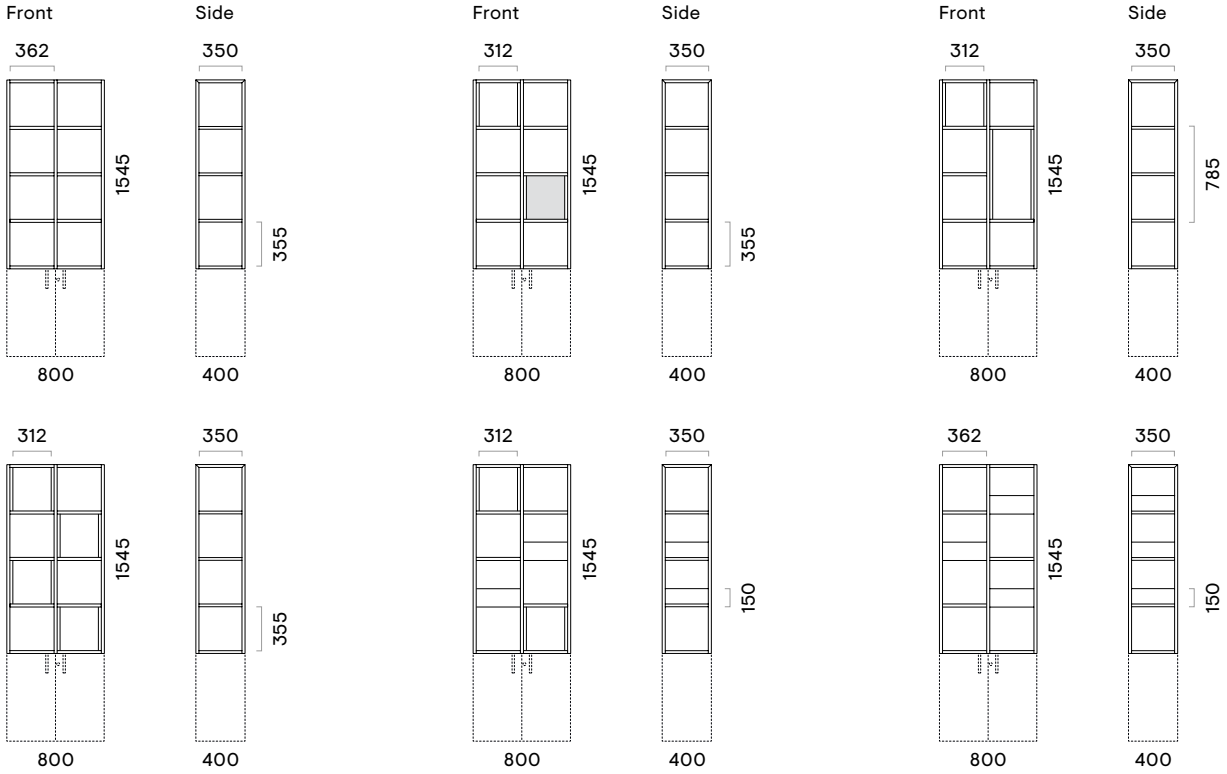

## Accessories

### Back panels

#### Melamine

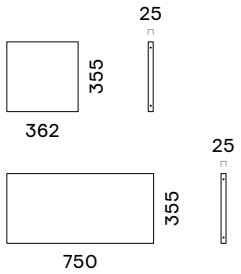

#### PET felt

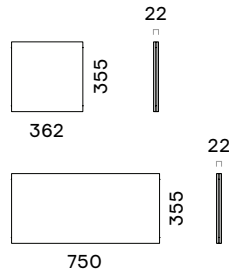

#### Perforated metal

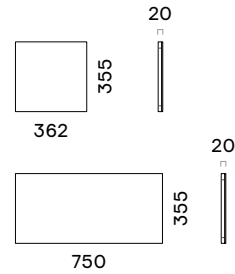

### Metal planter boxes

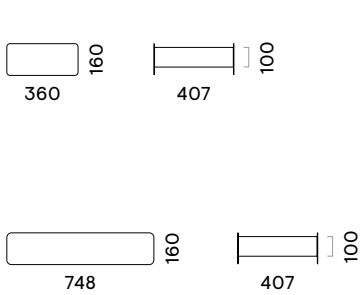

### Metal screen holders

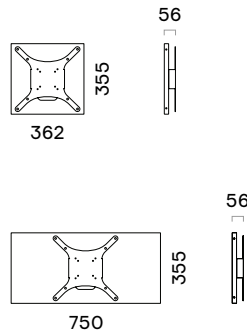

### Metal cable tray for cable management

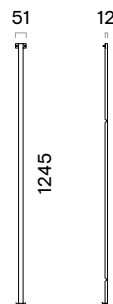

### Metal book-ends

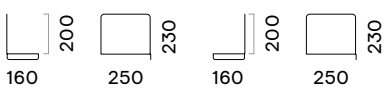

### PET felt basket

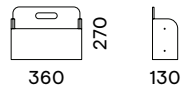

## Additional information

- You can only combine frames and sets of shelves of the same height.

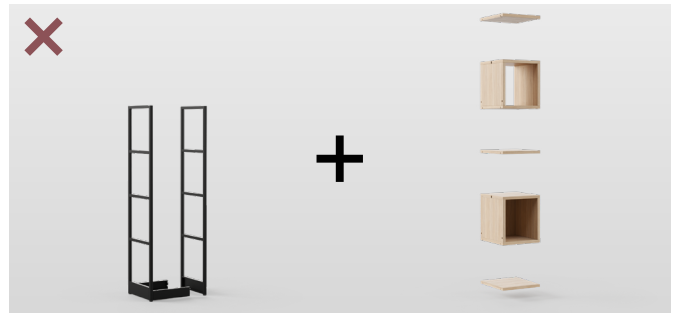
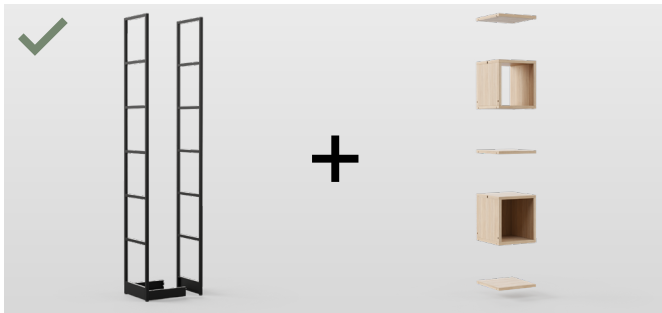

- Metal frames should be always assembled together with sets of shelves, planter boxes, open/closed shelf boxes or cabinet with drawer.

- Sets can be chosen individually and placed in various positions upon assembly.

- Open/closed shelf boxes and a cabinet with a drawer cannot be mounted on the top of each other.

- Cabinet with a drawer can be mounted only in the two height levels – 1H and 2H.

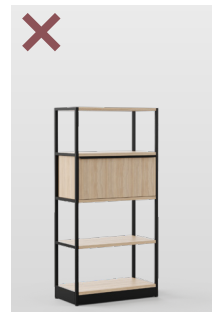
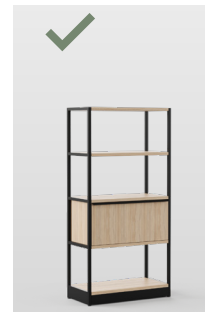
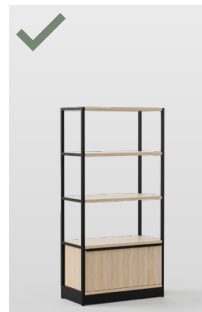

- Only one drawer can be placed per one vertical module.

- Back panels cannot be mounted on the back of the open shelf box.

- Planter box care. Please note that the inner part of the planter box is not protected from the moisture. It is recommended to follow the Melamine or Veneer cleaning and care instructions.



- Convenient electrical solutions for wire management. The cable is routed through a metal tray down to the central frame and further out through the plinth. The power socket block can be hidden under any bottom shelf and you can run a cable through the special cut-outs in the plinth. After the assembly, if needed, the power socket block can be easily accessed by removing the bottom shelf. It is not possible to access the power socket block when it is placed under the shelf box or cabinet with drawer.



!

It is recommended to mount the screen holder only in the two height levels – 3H and 4H.

- The shelving unit is mounted on the top of the cabinet and fixed with screws.

- The total height of the cabinet and the shelving unit must not exceed the height level of 6H. E.g., if you choose 4H cabinet, you should use not higher than 2H shelving unit to mount on the top. If you choose 3H cabinet, you should use not higher than 3H shelving unit.



!

When mounting 4H shelving units on the cabinets, it is recommended to additionally fix them to the wall or ceiling.

- For connecting the combinations of shelving units, please use sets of connecting components. The components have to be ordered separately as additional items.



- It is recommended to attach all the combinations to the floor (1). The necessary brackets are always included in the product package, bolts must be selected individually according to the type of floor. If it is not possible to fix the combination to the floor, please attach it to the wall (2) or use the counterweights (3). Fixing components and counterweights can be ordered separately as additional items.



! —————

Important: Furniture with natural veneer décor is sensitive to direct sunlight and colour tone changes can occur over time. Adding new items to the same space as existing veneer products of the same design might result in veneer colour tone variations. Veneer must be protected from deep scratches, intense light and prolonged exposure to liquid stains. It is recommended to follow the veneer cleaning and care instructions.

# Stability measures

	3H		4H		5H		6H	
	Shelves and boxes	Shelves and drawer	Shelves and boxes	Shelves and drawer	Shelves and boxes	Shelves and drawer	Shelves and boxes	Shelves and drawer
<b>W = 400 mm</b>		✗		✗		✗		✗
<b>W = 800 mm</b>	12 kg 	12 kg 	12 kg 	12 kg 	12 kg 	12 kg 		
<b>W ≥ 1200 mm</b>	✓	12 kg 	✓	12 kg 	✓	12 kg 		
<b>with screen holder</b>								

	2H	3H		4H	
	Planter box	Shelves and box	Box and drawer	Shelves and box	Shelf, box and drawer
<b>W = 800 mm</b>	✓	✓	12 kg	✓	12 kg

	Overall height ≤ 5H	Overall height = 6H	Overall height > 6H
	<b>W = 800 mm</b>	✓	

- Mandatory. Please use specified counterweights!
- Mandatory. Please fix your combination to the floor!
- Mandatory. Please fix your combination to the wall!
- ✓ No mandatory measures.
- ✗ Combination is not available.

\* Suitable only for combinations standing near the wall. Freestanding combination in open spaces is not allowed.