

Tribeca System



Tribeca is a modular and flexible collection of emphasized dimensions, intended for spacious interiors. Big feather-filled cushions add to the comfort of this collection's pieces. The elements of this system that are readily connectable in all directions, enable creation of an infinite number of spatial compositions, equally functional in either private or public contexts. The dynamic visual rhythm of the pieces' backside accentuates Tribeca's design. The pieces of

exaggerated size and geometric arcs are designed as flexible and separate structures, making Tribeca a sitting arrangement capable of reshaping the new complexity of the modern living marked by excessive planning.

Designed by **Zoran Jedrejčić**

Tribeca System



General dimensions

Height	79cm
Seat Height	44cm
Seat Depth	78cm
Seat Depth with cushion	60cm

Structure Solid Wood, Multilayer Plywood

Suspension Elastic Webbing

Seat & Backrest Multilayer HR Foam, Polyester Wadding

Cushions Feathering

Legs H 6cm Solid Wood, included Silicone Pads Black RAL 9005

Upholstery Fabric

Recommended Fabrics Orsetto, Rico, Boemian, Main Line Flax, Blackwood, Lario, Nomi, Azura, Azalea

Tabletop Oak - Natural / White Oil (**O/N**)
Oak - Black RAL 9005 (**O/B**)
American Walnut - Natural Oil (**W/N**)
Black Glass

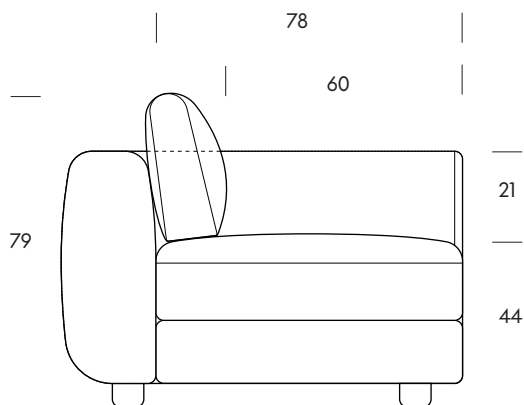

Suggested Fabric Colours

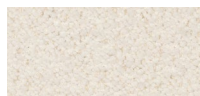

Volumen 900 - Orsetto 01/2

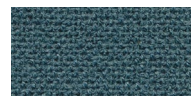

Volumen 700 - Boemian 624.050

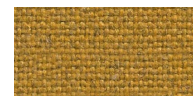

Volumen 400 - Lario III

Product information website
<http://volumen.ba/collection/tribeca/>



Made from FSC-certified wood and other controlled materials.

Tabletop



Black Glass



Oak - Natural / White Oil

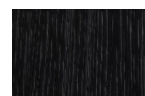

Oak - Black RAL 9005

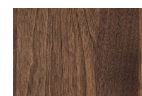

American Walnut - Natural Oil

Tribeca System

Seat Height
Seat Depth
Height

44cm
60cm
79cm

End Unit TR11
126×102×79cm

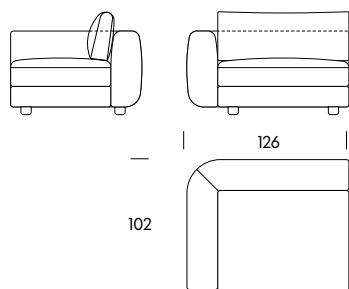

End Unit TR12
126×102×79cm

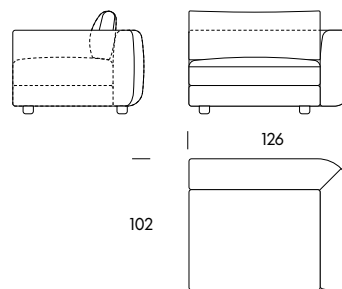

Armchair TR13
102×102×79cm

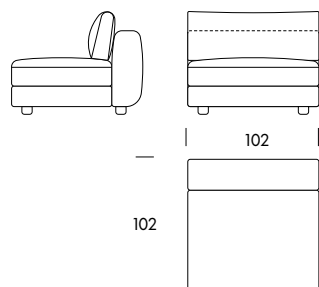

Three Seater Sofa TR30
252×102×79cm

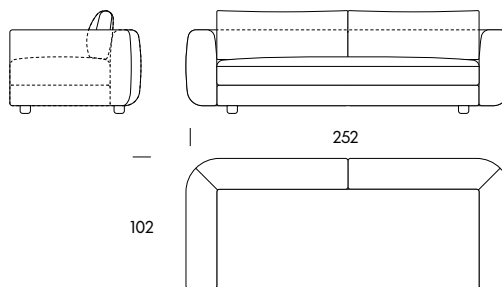

End Unit TR31
228×102×79cm

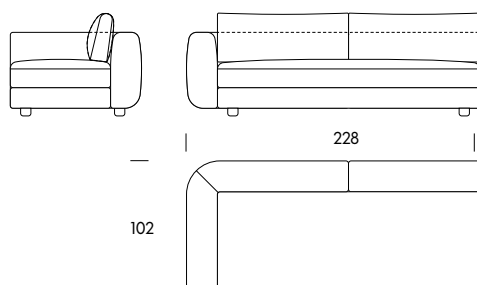

End Unit TR32
228×102×79cm

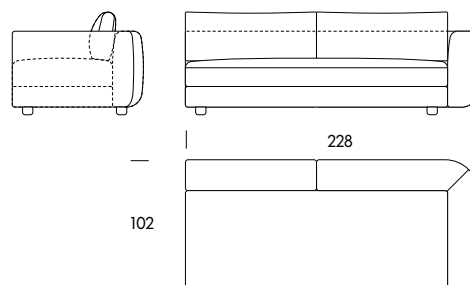

Tribeca System

Seat Height
Seat Depth
Height

44cm
60cm
79cm

Extension TR33
204×102×79cm

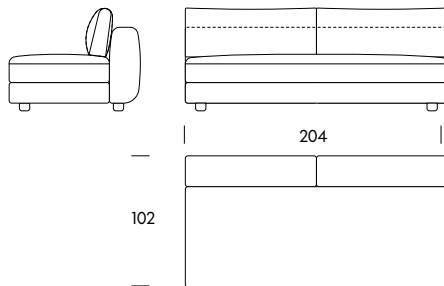

One Seater Extension TR40
160×102×79cm

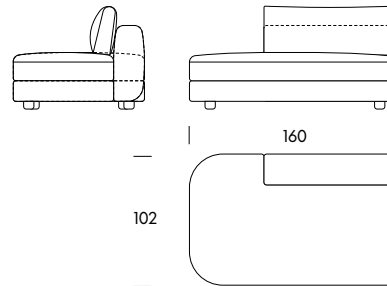

One Seater Extension TR41
160×102×79cm

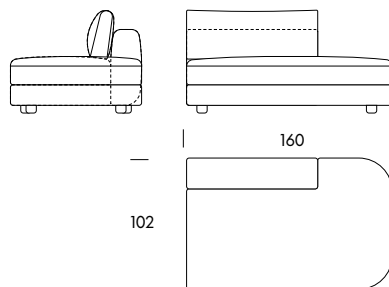

Chaise Longue TR42
126×184×79cm

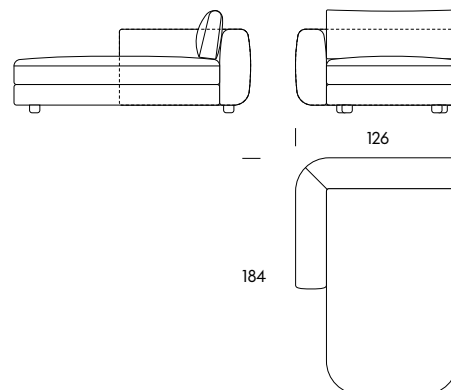

Chaise Longue TR43
126×184×79cm

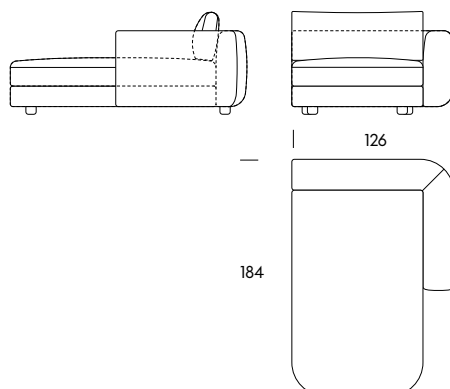

One Seater TR44
184×102×79cm

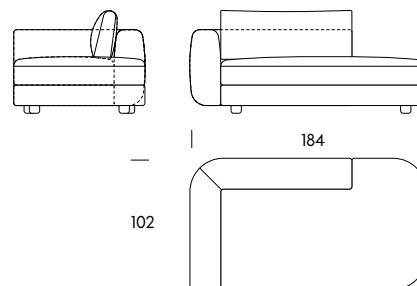

Tribeca System

Seat Height
Seat Depth
Height

44cm
60cm
79cm

One Seater TR45
184×102×79cm

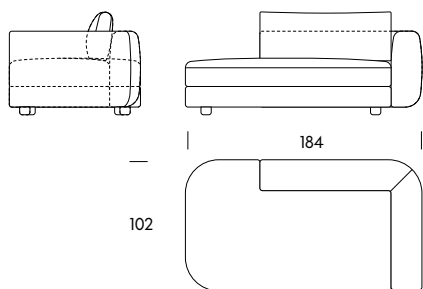

Coffee Table Extension TR60 Table
60×102×22cm

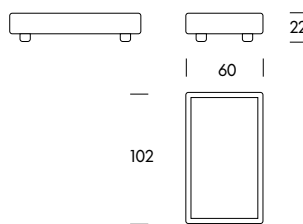

Pouf TR102
102×102×44cm

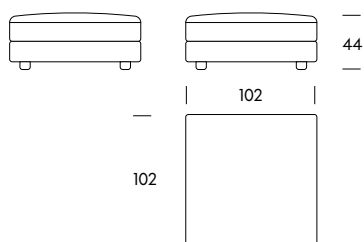

Pouf TR60
60×102×44cm

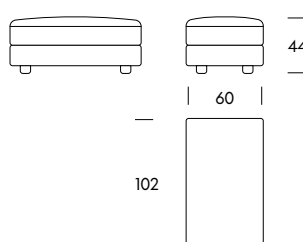

Pet Bed Extension TR60 Pet
60×102×32cm

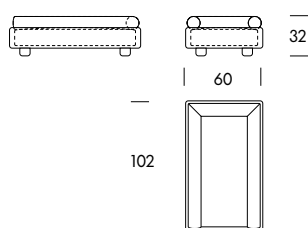

Tribeca System

Seat Height
Seat Depth
Height

44cm
60cm
79cm

Proposal 01
TR13

102×102cm



Proposal 02
TR30

252×102cm

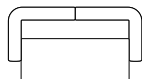

Proposal 03L
TR44

Proposal 03R
TR45
184×102cm



Proposal 04L
TR31, TR60 Table

Proposal 04R
TR60 Table, TR32
288×102cm

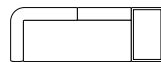

Proposal 05L
TR31, TR102

Proposal 05R
TR102, TR32
330×102cm

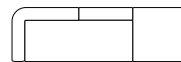

Proposal 06L
TR31, TR41

Proposal 06R
TR40, TR32
388×102cm

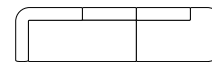

Proposal 07
TR31, TR32

456×102cm

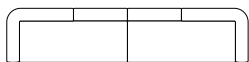

Proposal 08L
TR31, TR43

Proposal 08R
TR42, TR32
354×184cm

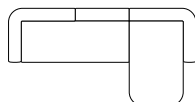

Proposal 09L
TR31, TR60 Table, TR43

Proposal 09R
TR42, TR60 Table, TR32
414×184cm

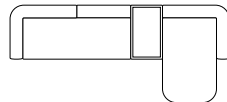

Proposal 10L
TR31, TR102, TR43

Proposal 10R
TR42, TR102, TR32
456×184cm

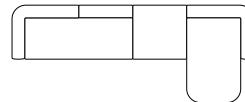

Proposal 11L
TR31, TR13, TR43

Proposal 12R
TR42, TR13, TR32
456×184cm

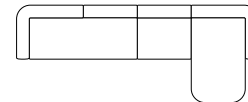

Proposal 12L
TR40, TR43

Proposal 12R
TR42, TR41

286×184cm

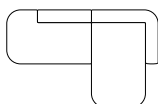

Proposal 13L
TR102, TR13, TR43

Proposal 13R
TR42, TR13, TR102

330×184cm

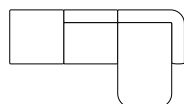

Proposal 14L
TR40, TR13, TR43

Proposal 14R
TR42, TR13, TR41

388×184cm

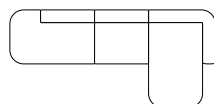

Proposal 15L
TR60 Table, TR33, TR43

Proposal 15R
TR42, TR33, TR60 Table

390×184cm

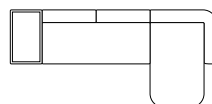

Proposal 16L
TR102, TR33, TR43

Proposal 16R
TR42, TR33, TR102

432×184cm

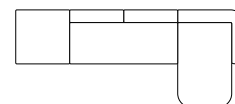

Proposal 17L
TR40, TR33, TR43

Proposal 17R
TR42, TR33, TR41

490×184cm

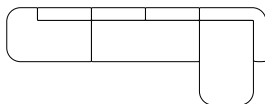

Proposal 18
TR40, TR41

320×102cm



Proposal 19
TR40, TR13, TR41

422×102cm



Proposal 20L
TR31, TR30

Proposal 20R
TR30, TR32

330×252cm

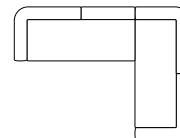

Proposal 21L
TR31, TR60 Table, TR30

Proposal 21R
TR30, TR60 Table, TR32

390×252cm

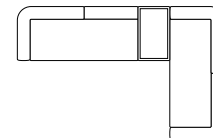

Tribeca System

Seat Height
Seat Depth
Height

44cm
60cm
79cm

Proposal 22L
TR31, TR102, TR30

Proposal 23L
TR31, TR13, TR30

Proposal 24L
TR60 Table, TR33, TR30

Proposal 25L
TR102, TR33, TR30

Proposal 26L
TR40, TR33, TR30

Proposal 22R
TR30, TR102, TR32

Proposal 23R
TR30, TR13, TR32

Proposal 24R
TR30, TR33, TR60 Table

Proposal 25R
TR30, TR33, TR102

Proposal 26R
TR30, TR33, TR41

432x252cm

432x252cm

366x252cm

408x252cm

466x252cm

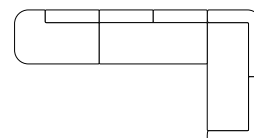
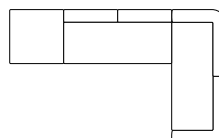
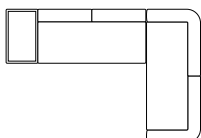
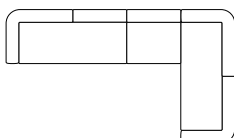
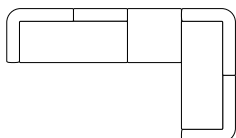

Proposal 27L
TR31, TR31, TR60 Table

Proposal 28L
TR31, TR31, TR102

Proposal 29L
TR31, TR31, TR12

Proposal 30L
TR31, TR31, TR43

Proposal 31L
TR31, TR31, TR41

Proposal 32L
TR31, TR31, TR32

Proposal 27R
TR60 Table, TR32, TR32

Proposal 28R
TR102, TR32, TR32

Proposal 29R
TR11, TR32, TR32

Proposal 30R
TR42, TR32, TR32

Proposal 31R
TR40, TR32, TR32

Proposal 32R
TR31, TR32, TR32

330x288cm

330x330cm

330x354cm

330x354cm

330x388cm

330x456cm

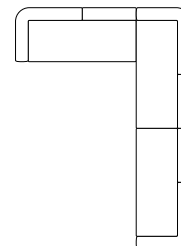
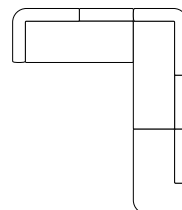
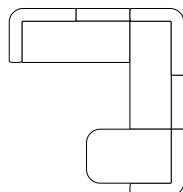
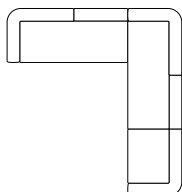
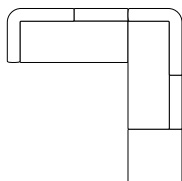
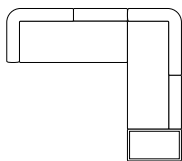

Proposal 33L
TR31, TR33, TR31, TR32

Proposal 34L
TR31, TR60 Table, TR31, TR41

Proposal 35L
TR31, TR102, TR31, TR41

Proposal 36L
TR31, TR13, TR31, TR41

Proposal 33R
TR31, TR32, TR33, TR32

Proposal 34R
TR40, TR32, TR60 Table, TR32

Proposal 35R
TR40, TR32, TR102, TR32

Proposal 36R
TR40, TR32, TR13, TR32

534x456cm

390x388cm

432x388cm

432x388cm

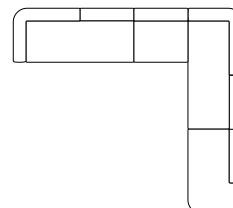
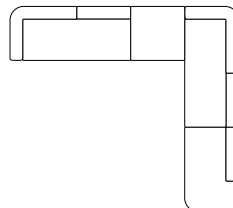
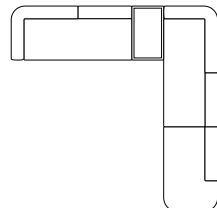
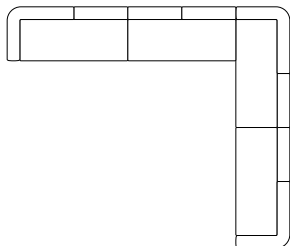

Tribeca System

Seat Height
Seat Depth
Height

44cm
60cm
79cm

Proposal 37L
TR31, TR33, TR31, TR41

Proposal 37R
TR40, TR32, TR33, TR32

534×388cm

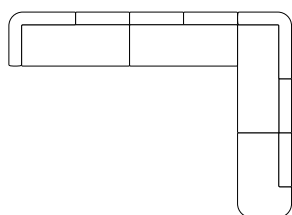

Proposal 38L
TR40, TR33, TR31, TR13, TR43

Proposal 38R
TR42, TR13, TR32, TR33, TR41

466×456cm

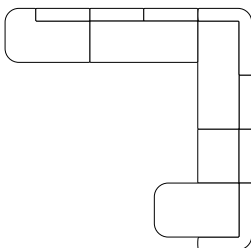

Proposal 39L
TR40, TR33, TR31, TR41

Proposal 39R
TR40, TR32, TR33, TR41

466×388cm

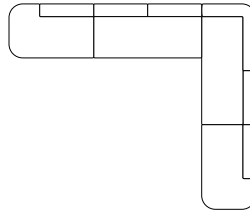

Proposal 40L
TR40, TR33, TR31, TR32

Proposal 40R
TR31, TR32, TR33, TR41

466×456cm

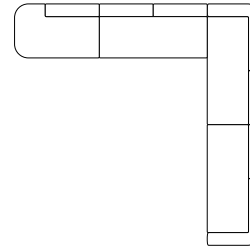

Proposal 41
TR31, TR102, TR32

330×330cm

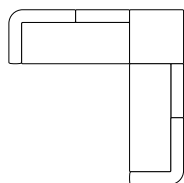

Proposal 42L
TR31, TR102, TR33, TR43

Proposal 42R
TR42, TR33, TR102, TR32

330×432cm

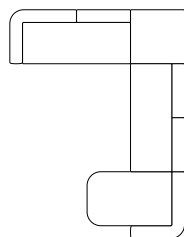

Proposal 43
TR11, TR33, TR102, TR33, TR12

432×432cm

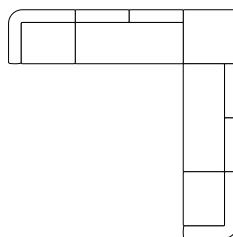

Proposal 44
TR40, TR33, TR102, TR33, TR41

466×466cm

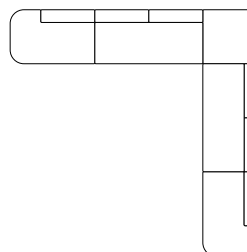

Proposal 45L
TR40, TR33, TR102, TR33, TR43

Proposal 45R
TR42, TR33, TR102, TR33, TR41

466×432cm

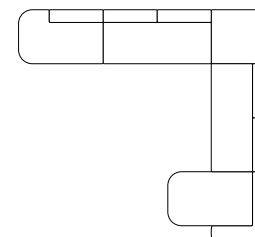

Proposal 46
TR31, TR33, TR102, TR33, TR32

534×534cm

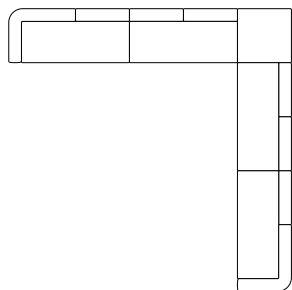

Proposal 47
TR11, TR12

252×102cm

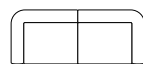

Proposal 48
TR11, TR13, TR12

354×102cm

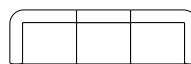

Proposal 49
TR11, TR13, TR13, TR12

456×102cm

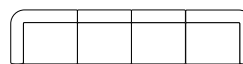

Tribeca System

Seat Height
Seat Depth
Height

44cm
60cm
79cm

Proposal 50L
TR11, TR13, TR13, TR41

Proposal 50R
TR40, TR13, TR13, TR12

490×102cm

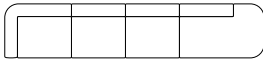

Proposal 51L
TR42, TR13, TR13, TR12

Proposal 51R
TR11, TR13, TR13, TR43

456×184cm

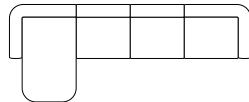

Proposal 52L
TR42, TR13, TR13, TR41

Proposal 52R
TR40, TR13, TR13, TR43

490×184cm

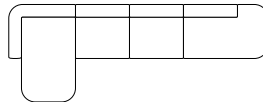

Proposal 53
TR11, TR13, TR13, TR102, TR13, TR13, TR12

432×432cm

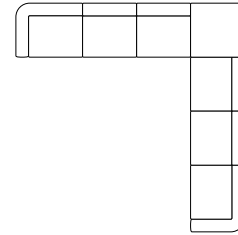

Proposal 54L
TR11, TR13, TR13, TR102, TR13, TR13, TR43

Proposal 54R
TR42, TR13, TR13, TR102, TR13, TR13, TR12

432×432cm

